

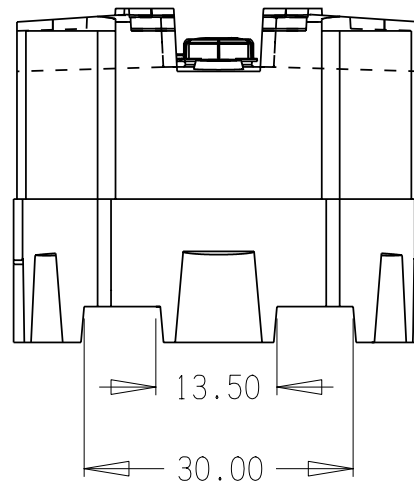

STANDARD 150 SQUARE STACKABLE "STANDARD PACKAGE OF OPTIONAL EQUIPMENT"

ITEM	DESCRIPTION	QTY	P/N
1	150 GAL TANK W/ 6" CAP, (1) BUNG LOCATIONS [ANGLED] AND 2" BOTTOM DRAIN - NATURAL [HDLPE]	1	66508
2	HEAVY DUTY BASE - 4 WAY PALLET JACK ACCESS - BLACK[HDLPE]	1	65549
3	SII PROPRIETARY 2" NPS REPLACEABLE BUNG W/ VITON O-RING SEAL - [GLASS FILLED PP]	1	34100008 33100039
4	2" NPS RIEKE BUNG PLUG WITH EPDM GASKET - [PE]	1	34700340
5	6" HEAVY DUTY CAP W/ 2" NPS CENTER OPENING AND EPDM GASKET - [PE] INCLUDES LANYARD	1	34700391
6	SII PROPRIETARY 2" VACUUM RELIEF VENT WITH EPDM DISK AND GASKET - [PE] AVERAGE GRAVITY FLOWRATE OF 70 GAL/MIN	1	34700854
7	2" BANJO STANDARD PORT BOTTOM DRAIN VALVE WITH TEFLON BALL AND SEATS AND 18/8 SS BOLTS [GLASS FILLED PP] INCLUDES DUST CAP AND LANYARD	1	34700718

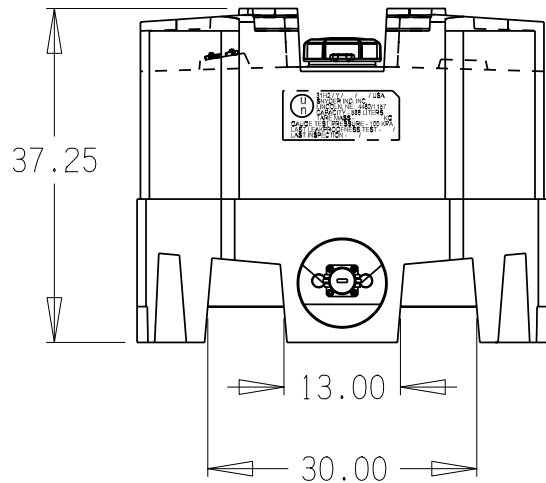
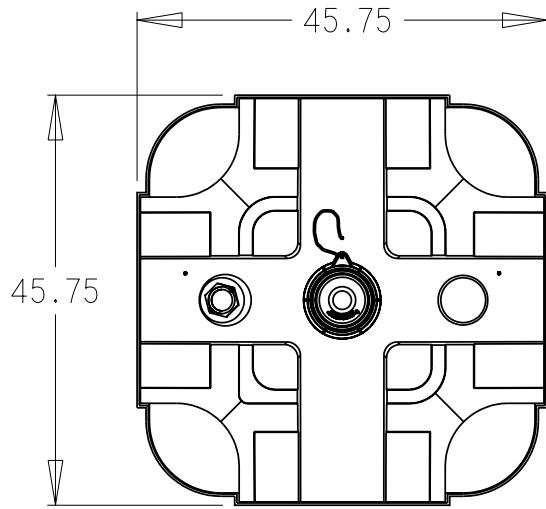

UN MARKING READS:

 31H2/Y/ / / USA
 SNYDER IND. INC.
 LINCOLN, NE. 4462/1157
 CAPACITY - 568 LITERS
 TARE MASS - KG
 GAUGE TEST PRESSURE - 100 KPA
 LAST LEAKPROOFNESS TEST - /
 LAST INSPECTION - /

(all dimensions in inches)

PART # TANK: 66508

STANDARD 150 GALLON SQUARE STACKABLE IBC

REF#: 0000

01/04/11